

VISIT US AT : [WWW.NWSEATCOVERS.COM](http://WWW.NWSEATCOVERS.COM)  
VISIT US AT : [WWW.SCCNORTHWEST.COM](http://WWW.SCCNORTHWEST.COM)

## FRONT SEAT COVERS

### 1 HEADREST REMOVAL

Remove the headrest by pushing the button. If there is a pinhole instead of a button, insert the longer, straight end of an "s" clip into the pinhole of the bracket.

**DO NOT** remove active headrests, use the velcro opening at the top of backrest cover for easy install

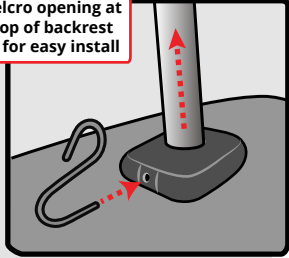

### 2 CUSHION COVERS

Included for extra layer of spill protection. They protect leather seats from abrasion. Lay the sub-liners on top of your cushions and install the driver and passenger seat cushion covers on top.

Locate the northwest tag stitched on the outside of the cushion covers. These tags identify the doorside of the seat that they should be placed on. Push straps between the backrest and cushion, then towards the front under the seat.

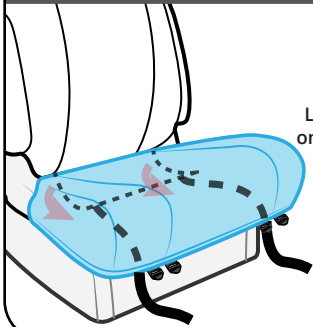

### 3 STRAPS & BUCKLES

Insert straps into the outer buckles. Pull the straps downwards and tight. Attach the elastic loop at the back end of cushion cover with an "s" hook to the underside of the seat.

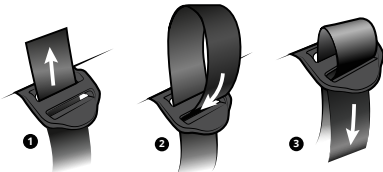
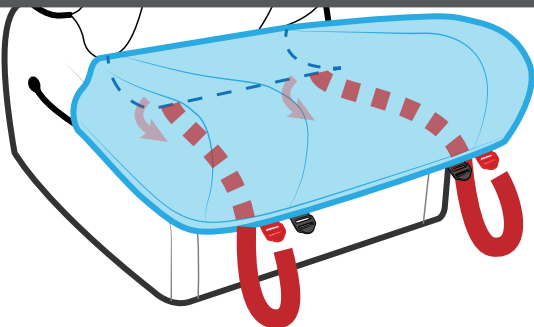

### 4 HOOK & LOOPS

Pull chord end closest to the door through the space between the backrest and seat cushion. Pull the loop at the opposing end around the side to the back of the seat.

**PLEASE** use eye protection when attaching elastics and hooks.

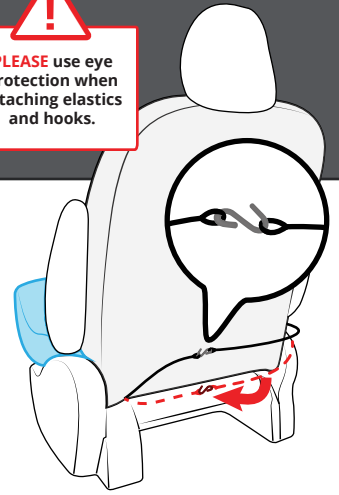
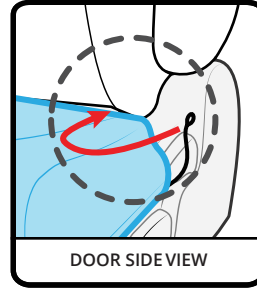
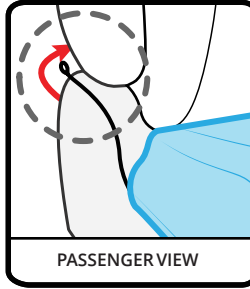

### 5 BACKREST COVER

Identify the driver and passenger backrest covers and pull them down over your backrests. If your backrests have large bolstered sides, it may be necessary to compact them with your hands until the covers are all the way down.

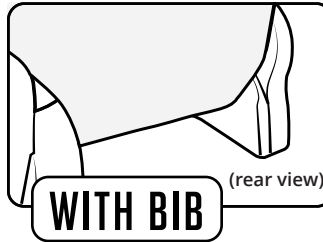

If your hand can't pass through to the back between the backrest and cushion, your seat has a bib. The backrest cover will have straps on the front tab and elastics/velcro on the back. Push the straps between the backrest and cushion, and below the cushion towards the front, and then attach them to the inner buckles. Attach the velcro strip at the back to the carpeting on the seat. Or, if there are elastics, attach them using the "s" clips to the underside of your cushion.

#### TIP FOR BETTER FIT:

While tightening straps/velcro, push downward on the backrest frontside to smooth wrinkles.



If backrests have side impact airbag tags, make sure to install with the side airbag tags over the airbags.

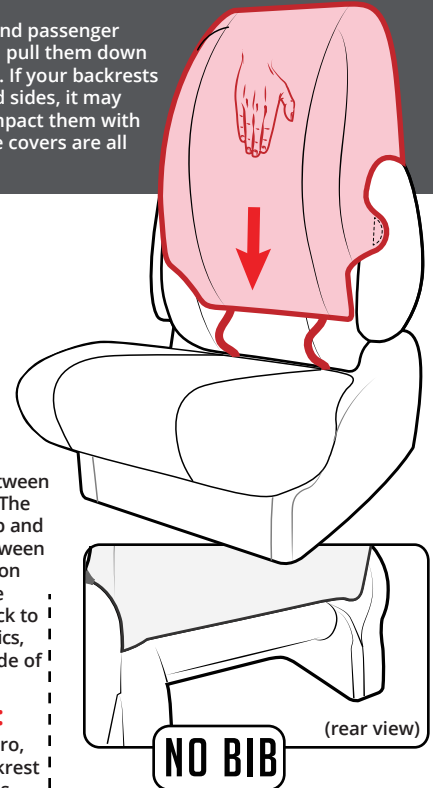

If your hand can pass through to the back between the backrest and cushion, your seat has no bib. Your backrest cover will have a carpeted tab and a velcro strip on the back. Push the front tab between the backrest and cushion to the back, and attach to velcro.

### 6 HEADREST HOLES

Due to pattern complexity, some covers require headrest holes to be made after installation. Material will not run, and covers are fully warranted.

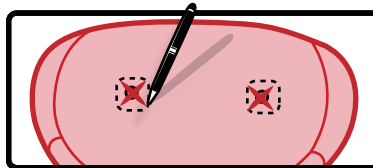

On the top of the backrest cover, mark with a pen an "X" over each headrest post.

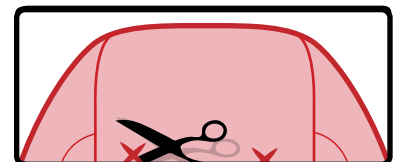

Pinch material, cut along the "X" markings, and tuck the material under the brackets.



# REAR SEAT COVERS INSTALLATION

## FOR TRUCKS



**DO NOT** remove active headrests, use the velcro opening at the top of backrest cover for easy install

### 1 HEADREST REMOVAL

Remove the headrest by repeating step one from front seat cover installation instructions.

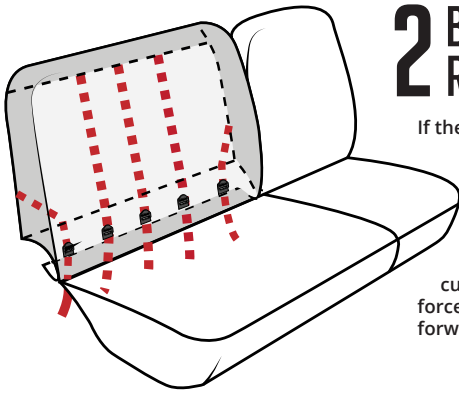

### 2 BACKREST REMOVAL

If the backrest is attached to the vehicle frame, your covers should be open backed. To make room for the straps to drop between backrest and vehicle frame, pull the cushion up. Often, this will force the backrest to move forward from the frame.

### 3 STRAPS & BUCKLES

Next, insert the straps into their corresponding buckles as shown.

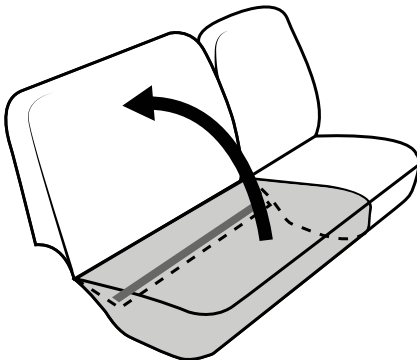
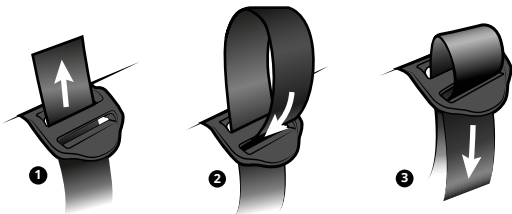

### 4 CUSHION COVER

During cushion cover installation, flip seat(s) up while tucking the velcro flap

## FOR CARS



**DO NOT** remove active headrests, use the velcro opening at the top of backrest cover for easy install

### 1 HEADREST REMOVAL

Remove the headrest by repeating step one from front seat cover installation instructions.

### 2 BACKREST REMOVAL

You may have to remove a bolt usually located at the back of the cushion. the cushion. Look for any latches on the front edge of the seat. If there are none, your cushion will be held on by plugs (you will be able to feel where they are). Pull up gently until the plug pops out and seat is released. If you are unsure, call your dealers service department for guidance.

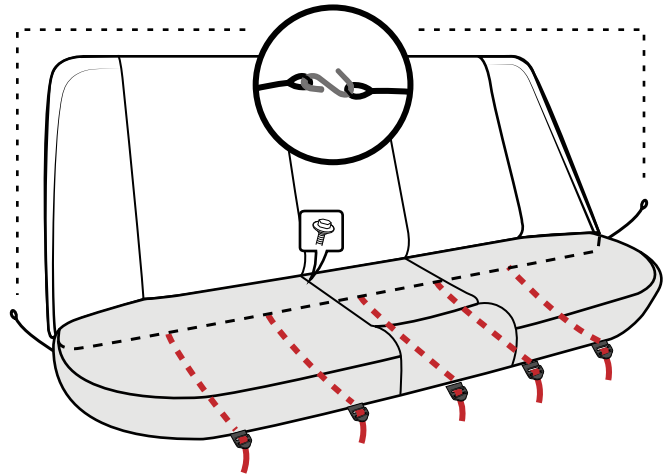

### 3 STRAPS & BUCKLES

Insert straps into their corresponding buckles. Pull the chord by their loops together, and connect with an "S" hook. Pull straps downwards to tighten.

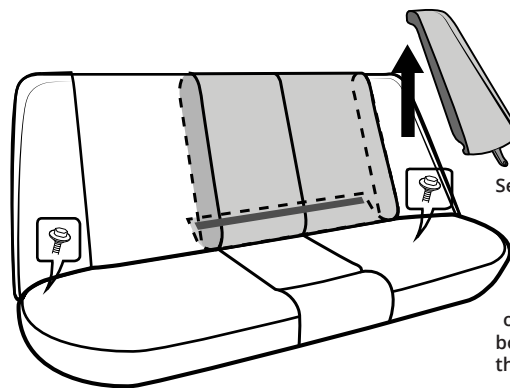

### 4 BACKREST COVERS

Secure backrest covers via velcro tabs. The bolsters are usually held in place by bolts placed at the bottom. Remove these bolts in order to detach the bolsters before installing the bolster covers.

